

AIAS 2018 International Conference on Stress Analysis

Dynamic behavior of wind turbines. An on-board evaluation technique to monitor fatigue

F. Cianetti^{a*}, A. Cetrini^a, M.L. Corradini^b, G. Ippoliti^c, G. Orlando^c

^aUniversity of Perugia - Department of Engineering, via Goffredo Duranti 67, 06125 Perugia, Italy

^bUniversity of Camerino – Scuola di Scienze e Tecnologie, via Madonna delle Carceri, 62032 Camerino (MC), Italy

^cUniversità Politecnica delle Marche - Department of Information Engineering, via Breccie Bianche, 60131 Ancona, Italy

Abstract

The evaluation of fatigue behavior of wind turbines, that is of supporting structures, blades or gear boxes, is always performed off-line, by post processing experimental acquisitions or simulation results. Moreover, the evaluation of potentiality of smart controls, that have the aim to avoid failures by reducing loads and consequently fatigue stresses, is performed in the same way. In this paper is presented a tool that allows to on-line evaluate and foresight fatigue potential damage by simply on time processing reference signals such as tower top acceleration (typical experimental acquisition) or tower base bending moment (typical numerical measure).

This evaluation technique is converted into a well know numerical code, oriented to control systems (Simulink), to be used into multibody simulation by co-simulation approach. This step allowed to verify its capabilities and the possibility to realize its physical prototype and to use its results as input variable for active control strategies oriented to minimize damage.

As test case a standard 5 MW wind turbine and a classical control logic were used.

© 2018 The Authors. Published by Elsevier B.V.

This is an open access article under the CC BY-NC-ND license (<http://creativecommons.org/licenses/by-nc-nd/3.0/>)

Peer-review under responsibility of the Scientific Committee of AIAS 2018 International Conference on Stress Analysis.

Keywords: wind turbine; fatigue; damage evaluation; control systems

* Corresponding author. Tel.: +39-075-5853728; fax: +39-075-5853703.

E-mail address: filippo.cianetti@unipg.it

1. Introduction

Wind turbines are typical machines subject to fatigue damage (Ragan et al. (2007)). The damage can be cumulated in the tower (Long et al. (2015)), in the blades (Marin et al. (2009)), in the gears (Nejad et al. (2014)), i.e. in all those parts subject to vibrations, cyclical loads, induced by the wind or by rotational motion.

In order to prevent interruption of operation or, in the worst case, accidents, on board control systems exist which monitor either the rotor speed or the wind speed (by means of anemometers) or the accelerations at the top of the tower. They operate the rotor braking procedures, or by rotations of the generator with respect to the wind direction or, rather, of the blades relatively to its axis (pitch), in order to minimize the loads on the various components of the machine, toward to high intensity of the wind speed, either persistent or instantaneous (gusts) (Corradini et al. (2018)).

In the literature there are various examples of control systems designed to minimize fatigue damage but almost all verified *ex post* (Ziegler et al. (2018)). Their performances are evaluated either in absolute terms or in relative ones through more or less sophisticated numerical models, evaluating the fatigue behavior of the generator (i.e. damage) starting from the time histories or the PSD functions acquired by the simulations. Some examples of controls based on a *on line* estimation of damage are found in the literature, but are based on hypotheses of stationarity of the process (Barradas-Berglund et al. (2015)).

The control systems are also designed on the basis of the estimated relationships between the physical parameters that can be measured in the field (i.e. accelerations) and the variables directly linked to the damage (i.e. bending moment of tower or blades) (Gasch et al. (2012)).

In this work, authors adopt a method of *on line* evaluation of fatigue behavior and present its translation in a computing environment dedicated to the dynamic multidomain simulation of mechanical systems and to the design and verification of control systems. This passage made it possible to verify how the results obtainable from the evaluation tool can be evaluated on line or directly by the physical measurements made on the turbine or, in any case, by those obtainable through more or less complex dynamic models of the generator itself, at the limit through the adoption of one degree of freedom (*sdof*) simple models (Cetrini et al. (2018)).

This allowed to verify how the proposed evaluation tool can be used within classic active control techniques or innovative strategies (Cetrini et al. (2018)) oriented to damage minimization. It also allowed to verify its possible translation into an electronic card to be inserted in the wind turbine control units.

In order to evaluate its capacity, a series of simulations were performed on a reference generator (Jonkman et al. (2009)), using multi body dynamic model (MBS) realized in a free-ware code considered as reference for the scientific community (NREL FAST). The analysis of the results demonstrated the concrete possibility to implement it on board and their effectiveness in allowing to extend life of the generators.

2. On line evaluation of fatigue damage

If a generic signal $\mathbf{x}(t)$ (i.e. acceleration, force, moment) is considered to evaluate the mechanical system or component fatigue behavior, to evaluate its durability performance the fatigue strength curve related to it has to be known and its expression is the following, similar to that of *Wohler* (Collins (1981)) curve for stress signals:

$$x_f = \alpha \cdot n^\beta \quad (1)$$

where x_f is the strength amplitude value of the signal related to an applied cycles number n , α is the intercept of the curve on the amplitudes axis for $n = 1$, β is the curve slope considered constant in the whole cycles range.

Its inverse representation is also valid:

$$N = \sqrt[\beta]{\frac{x_a}{\alpha}} \quad (2)$$

where N represents the strength cycles number when an amplitude value x_a of the alternating signal is applied.

The most common evaluation method of the fatigue behavior, i.e. of the damage, therefore, requires two further steps: to identify a damage model and to choose a counting and identifying method for the alternating cycles of the signal under examination.

The adoptable damage model is the linear damage cumulation law of *Palmegreen-Miner* (Collins (1981)). Regarding the cycles counting, the counting method considered as standard in this paper, but considered as such by the scientific community and by international standards, is the *Rain Flow Counting* (RFC) (Collins (1981)). The counting (RFC) identifies the closed hysteretic cycles defined by the signal and, generally, the cycles are collected in bands (*bins*) to reduce the result dimensions of this evaluation. A load spectrum, that is a three-column matrix, can be obtained in which the number of counted cycles \mathbf{n} , the associated mean value \mathbf{x}_m and amplitude value \mathbf{x}_a of the signal are represented in its generic row. All the counted cycles can also still kept in memory, with relative amplitude and mean value, without to be sampled in bands, obtaining, in this case, a spectrum with as many rows as many cycles were counted, that is assuming for each row $\mathbf{n} = \mathbf{1}$.

The first simplification hypothesis assumed in this paper is that the mean value of the generic cycle will be neglected.

Assuming the above hypothesis the load spectrum can be represented as shown below:

$$(\mathbf{x}_a, \mathbf{n}) \quad (3)$$

with respectively \mathbf{x}_a and \mathbf{n} the vectors of amplitude and number of applied or counted cycles.

By knowing spectrum (3), fatigue damage is evaluable by *Palmegreen-Miner* rule, that is by the following:

$$D_p = \sum_{i=1}^m \left[\frac{n_i}{\beta \frac{x_{a_i}}{\alpha}} \right] \quad (4)$$

where \mathbf{m} is the total number of counted cycles, D_p the cumulated damage (Collins (1981)). Subscript \mathbf{p} is used to remember that the damage, not being calculated necessarily starting from a stress value, is a *potential* damage, as defined in Cianetti (2012) and Cianetti et al. (2018), very useful for comparative analysis but not to be analyzed as the absolute value of the *real* damage.

Another definition, useful to better understand the subsequent steps proposed by the method object of the present paper, is that of *damage equivalent signal* (DES) (Corradini et al. (2018), Jonkman et al. (2005)), often used in the field of wind engineering.

Under the hypothesis of constant slope of the fatigue strength curve, by knowing the damage or equivalently the load spectrum, it is possible to define a stationary cyclic condition equivalent to the entire spectrum (Cianetti et al. (2018), Collins (1981)) in terms of damage. Given an arbitrary number of cycles, to which it is possible to assign the value of the total number of cycles \mathbf{m} , it is always possible to evaluate the equivalent amplitude value \mathbf{x}_{ades} of the signal which determines the same damage of the spectrum $(\mathbf{x}_a, \mathbf{n})$ by means of the following equation:

$$\mathbf{x}_{ades} = \alpha \cdot \left\{ \mathbf{m} \cdot \sum_{i=1}^m \left[\frac{\beta \sqrt{x_{a_i}}}{\alpha} / n_i \right] \right\}^\beta \quad (5)$$

that can be also expressed as follows by adopting damage definition (4):

$$\mathbf{x}_{ades} = \alpha \cdot [\mathbf{m}/D_p]^\beta \quad (6)$$

To evaluate the cumulative damage at a given moment in the life of the mechanical system requires to acquire the whole history of the signal, considered representative of its behavior, meaning as whole the one that goes from the first use of the machine, seamlessly, up to that moment.

This ideal approach is impossible to be followed both for reasons of memory space allocation and considering the

computational times necessary to count cycles through RFC and then to evaluate damage.

The authors idea was to monitor the potential damage of a generic machine by evaluating it at any of the operating times without taking up all the memory space required by the ideal methodology, evaluating it by adopting a mobile window Δt defined in the time domain, of appropriate characteristics (duration and sampling frequency).

Once the floating window has been defined, this will be the data buffer that will continuously be filled in for the evaluation of fatigue behavior.

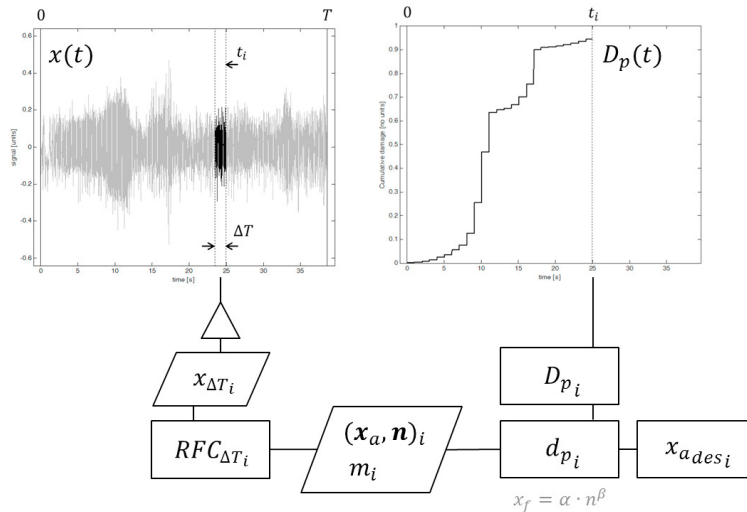

Fig. 1. Flow chart of proposed evaluation of damage time history

In figure 1 flow chart of the procedure proposed by author is shown.

When the mobile i -th window is post processed the load spectrum obtained by RFC is:

$$(x_\alpha, n)_i \tag{7}$$

Cloorman-Seeger or ASTM (Cloorman et al. (1986), ASTM (2011)) hypothesis is followed without considering the cycle mean value.

If a strength curve such as (1) is adopted, it is possible to define the i -th potential damage d_{p_i} , that will be called instantaneous damage, meaning by instantaneous the one associated to the current mobile window:

$$d_{p_i} = \sum_{k=1}^{m_i} \left[\frac{(n_k)_i}{\sqrt{\frac{(x_{\alpha k})_i}{\alpha}}} \right]^\beta \tag{8}$$

in which subscript i refers to i -th window and k to the generic spectrum cycle (7), counted in the same window. m_i is the total number of cycles counted in the window.

The cumulated damage at the generic instant, that is at the generic i -th window, will be:

$$D_{p_i} = \sum_{r=1}^i d_{p_r} \tag{9}$$

Similarly, the DES related to the window is:

$$x_{ades_i} = \alpha \cdot \left\{ m_i \cdot \sum_{k=1}^{m_i} \left[\sqrt{\frac{(x_{ak})_i}{\alpha}} / (n_k)_i \right] \right\}^\beta \tag{10}$$

$$x_{ades_i} = \alpha \cdot [m_i/d_{p_i}]^\beta \tag{11}$$

The value x_{ades_i} is strongly influenced by the number of cycles counted in the window, m_i , and therefore window by window, could vary in value, increasing or decreasing, without, however, meaning that the damage has really increased or decreased. For example, if two windows i -th and $(i + 1)$ -th generate the same instantaneous damage d_p but the two windows contain different number of cycles m_i and m_{i+1} , two different values of x_{ades} occur for the same damage. To overcome this result and have a value of x_{ades} comparable among the various windows and, therefore, independent of the number of cycles, the value of normalized DES has been defined \bar{x}_{ades} that is evaluated in the hypothesis of a number of cycles constant for all the windows. In the case of number of cycles constant and equal to **1** equation (11) becomes the following:

$$\bar{x}_{ades_i} = \alpha \cdot [d_{p_i}]^{-\beta} \tag{12}$$

3. Development of the tool in a control system design environment

The evaluation model described in the previous paragraph was then implemented in a computing environment dedicated to the dynamic multidomain simulation of mechanical systems and to the design and verification of control systems (Simulink).

Figure 2 shows the model of the fatigue behavior evaluation developed in this environment, capable to be interfaced with any control system in which the input signal represents one of the generic parameters that a multibody model or a real system allows to provide by virtual or real measurement (i.e. acceleration, velocity, displacement, bending moment, stress, strain).

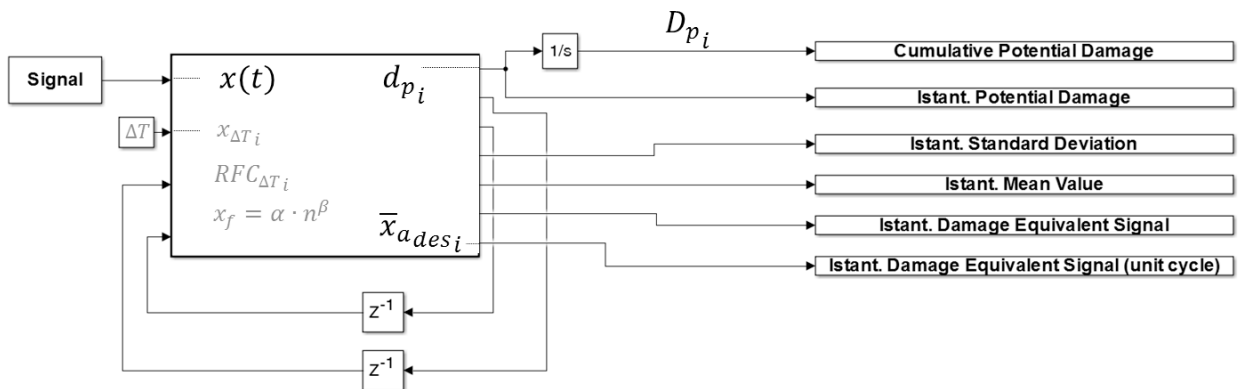

Fig. 2. Simulink model of the proposed damage evaluation tool

All the output parameters described in the previous paragraph and in particular the instantaneous damage, the cumulative damage, the alternating equivalent true and normalized values and, moreover, the mean value and the

standard deviation, also evaluated window by window, are traceable.

The Simulink model will represent the skeleton of an electronic board that will be created starting from this scheme and which will then be installed on board of a turbine prototype (Castellani et al. (2018)).

4. Validation of the evaluation method of instant damage

In order to evaluate the actual usefulness of these instantaneous parameters, the behavior of a generator in terms of cumulative damage of the tower base was analysed when controlled in standard mode (Gasch et al. (2012)) (Figure 3).

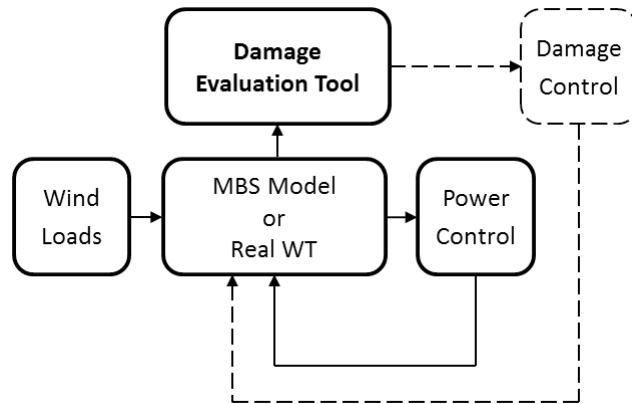

Fig. 3. Adopted power control strategy and possible development of a damage control one.

A multibody generator model, known in the literature, was used (Jonkman et al (2009)), characterized by a power of 5 MW and developed in NREL FAST (Figure 4).

The considered wind load condition is a random condition characterized by a velocity mean value typically defined as zone II (Gasch et al. (2012)) (i.e. velocity less than 12 m/s).

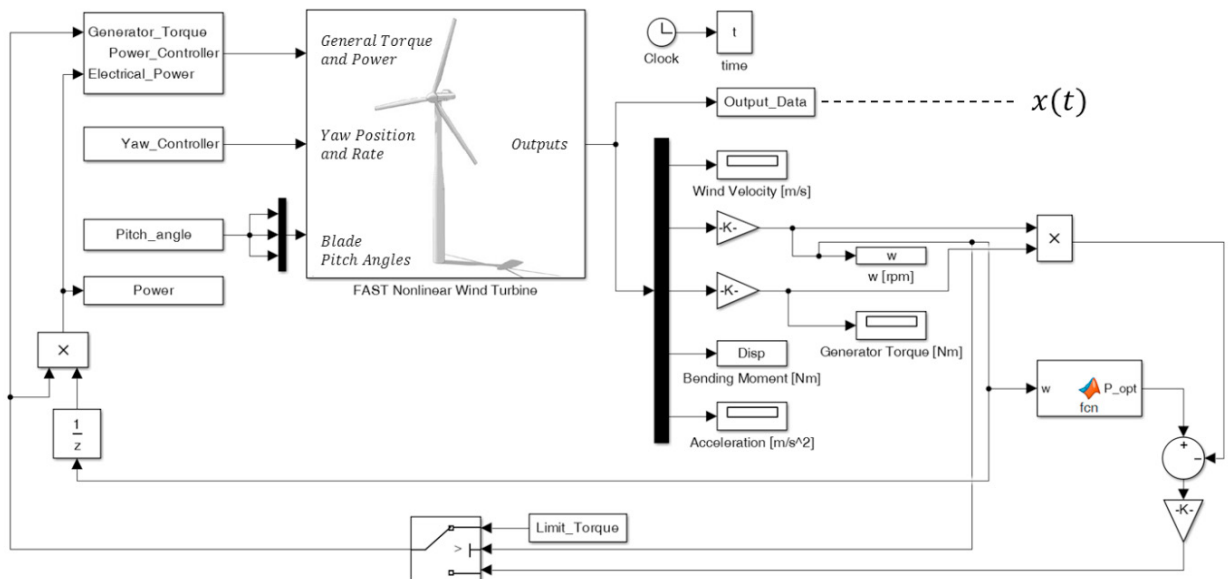

Fig. 4. Simulink model of WT (FAST MBS model) controlled by the adopted power control strategy.

The standard control in these conditions is a speed control that pushes the generator to develop the maximum power that can be delivered without taking into account the load conditions and, therefore, exclusively monitoring rotor and wind speed (Figures 3 and 4). In these cases the optimal pitch of the blades is not changed. In figure 4 a control branch has been identified (dashed line) that connects the model to the open loop damage assessment block without using the results for further control actions. In this case, the bending moment at the tower base was used as variable $x(t)$.

Through the experimental or numerical measurement of the accelerations at the top of the tower, however, it is possible through simplified *s dof* models to estimate on line the bending moment at tower base (Cetrini et al. (2018)). If a multibody model is available, as in this case, this variable can be *on line* obtained from the simulation.

Two time histories were generated and used for the simulation: a stationary one and a non-stationary one, in which some episodes of sudden variation of wind speed are evident (fig.5).

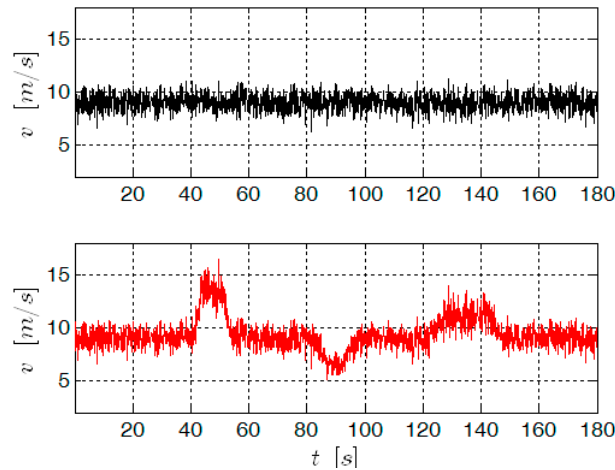

Fig. 5. Time histories (TH) of wind velocity used in the simulation. Upper figure TH: stationary wind; lower figure TH: non stationary wind

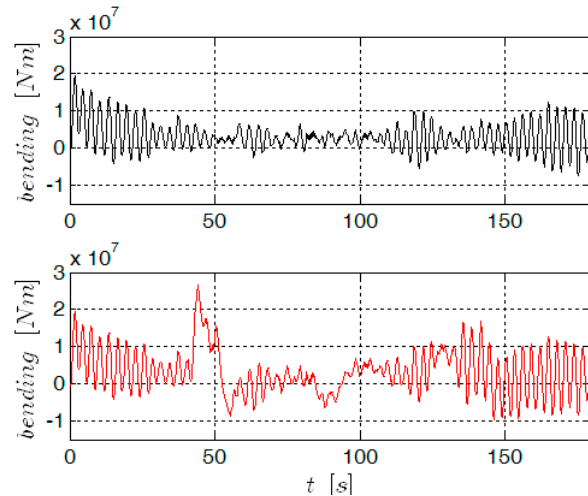

Fig. 6. Time history (TH) of bending moment at the tower base for the two load conditions. Upper figure TH: stationary wind; lower figure TH: non stationary wind.

In order to evaluate the damage parameters by means of the proposed tool, a fatigue strength curve was defined, expressed in terms of bending moment, described by the following parameters $\alpha = 1.92474 \cdot 10^8 [Nm]$ and $\beta = -0.2228 (1)$. A sampling step dt of 0.01 [s] and a floating window Δt of 5 [s], sufficient to capture the minimum natural frequency of the tower, were used.

Figure 6 compares the time trends of the bending moment obtained by the simulations, using the simulation model of Figure 4 and conducted with the two load conditions (fig.5).

Taking as reference the non-stationary wind simulation, figure 7 shows an instant of *on line* damage assessment (cycle counting) conducted on the *i*-th (24th) time window, by using the developed tool (fig.2).

The graphs of figures 8 and 9 show comparisons between the two load conditions in terms of instantaneous damage d_{p_i} and of a normalized damage equivalent signal $\bar{x}_{a_{des_i}}$. These two signals are the signals that instantaneously the module provides during the simulation.

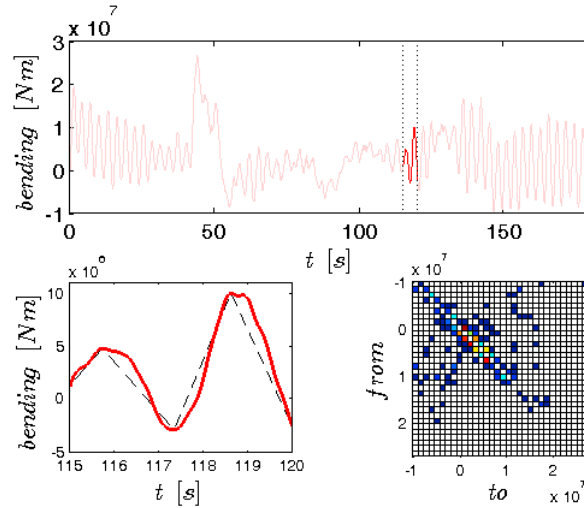

Fig. 7. Example of an evaluation procedure step (24th window). Rain flow counting of the time window.

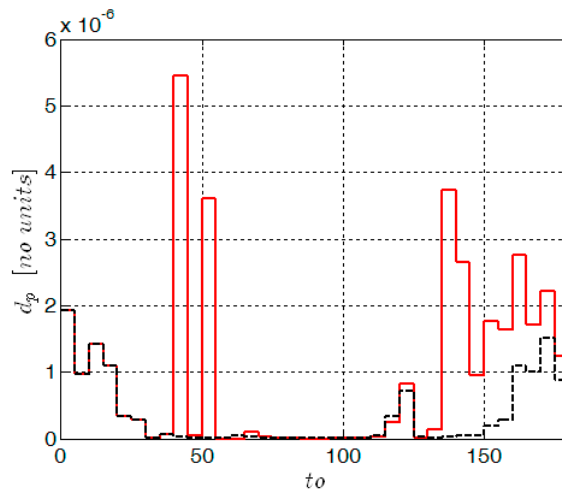

Fig. 8. Comparison between THs of instantaneous damage d_{p_i} obtained for the two simulations.
Red continuous line: non-stationary wind; black dashed line: stationary wind

In figure 10, the temporal trends of the cumulative damage obtained by the proposed evaluation tool are compared (fig.2).

The comparative analysis of bending moment and of instantaneous parameters time histories, such as the instantaneous damage and the normalized damage equivalent signal, confirms how the proposed model is able to grasp any significant variation of the process and, therefore, the instants in which this implies an increase of fatigue damage.

In order to verify not only the ability to qualitatively evaluate the cumulative potential damage and its variations,

but also to obtain its real value, in Figure 11 the trends of the cumulative damage, obtained with the proposed method and delivered to the scientific community of controllers, are compared with the real ones obtained using the reference technique that applies the rain flow counting and the damage evaluation in post processing, over the entire story as time increases. It is possible to observe how the trends are very similar and that the online evaluation amplifies the instantaneous evaluation of sudden changes (i.e. time histories section from 40 and 50 [s]). This sensitivity to changes in the process increases the positive judgment on the proposed method, especially if the objective is to deliver this evaluation tool to a control strategy aimed at minimizing damage.

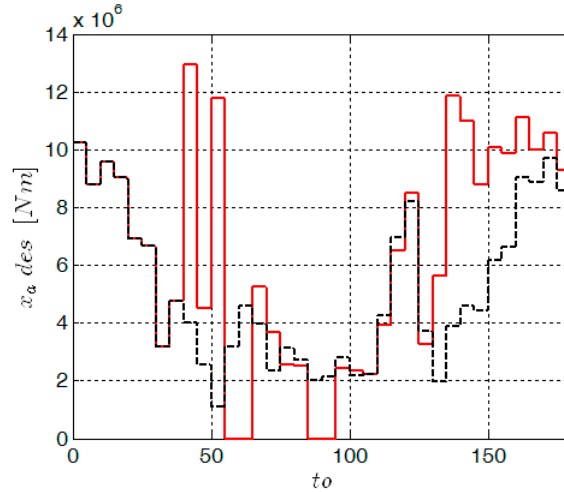

Fig. 9. Comparison between normalized damage equivalent signal $\bar{x}_{\alpha_{des_i}}$ obtained for the two simulations. Red continuous line: non-stationary wind; black dashed line: stationary wind

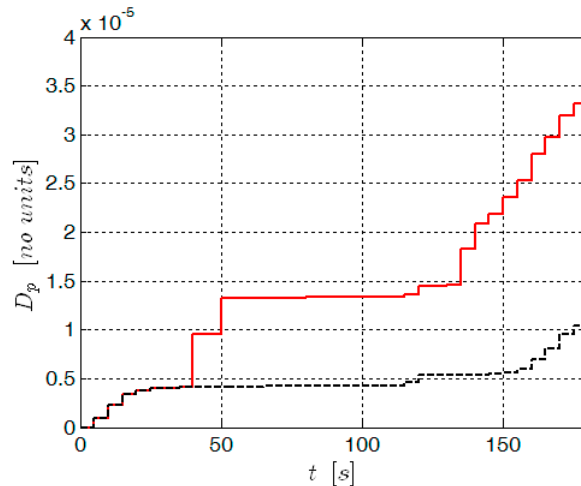

Fig. 10. Comparison between cumulative damage time histories obtained by proposed module for the two simulations. Red continuous line: non-stationary wind; black dashed line: stationary wind

4. Conclusions

This paper presents a tool for an on-line evaluation and foresight of fatigue potential damage. This theoretical procedure has developed into a numerical model (Simulink) to verify its capability to be introduced into a numerical multibody model of a generic wind turbine or, better, to be implemented into an electronic device useful to monitor real turbine behavior.

In this paper the Simulink model is introduced. To verify the capability of the tool to give useful signals for the

fatigue behavior control of wind turbine a reference turbine model was used. The analyses result has shown as the on line fatigue evaluation tool is capable to obtain signals very close to the real behavior and so useful to drive the control toward the aim of minimizing damage and maximize turbine life.

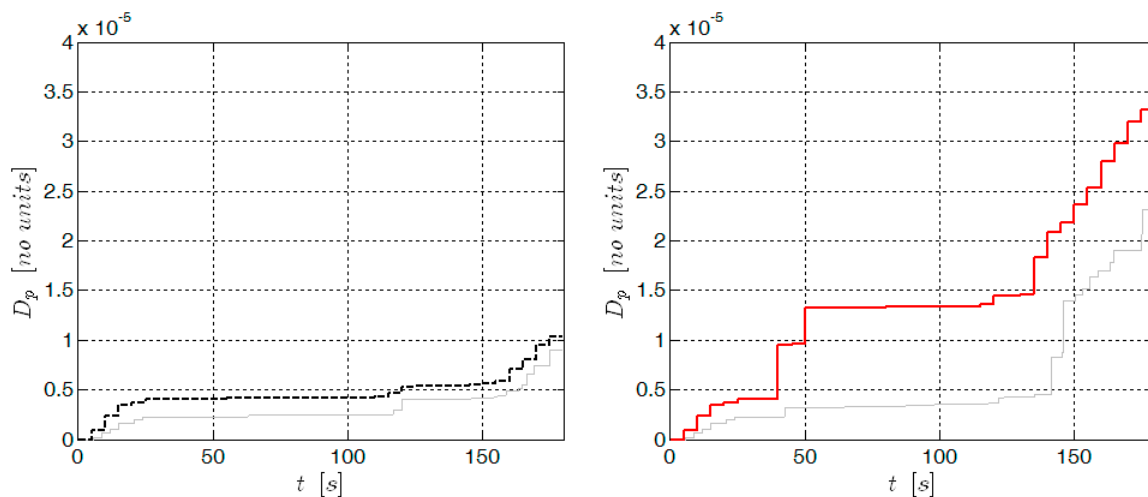

Fig. 11. Comparison between cumulative damage time histories obtained by proposed module and by classical approach (post-pro evaluation).
Left figure (stationary wind): black dashed line, proposed evaluation; gray continuous line, real value.
Right figure (non-stationary wind): red continuous line, proposed evaluation; gray continuous line, real value.

Acknowledgements

This research activity was financed by Italian PRIN funding source (Research Projects of National Interest - Progetti di Ricerca di Interesse Nazionale) by a financed project entitled SOFTWIND (Smart Optimized Fault Tolerant WIND turbines).

References

- ASTM Standard E 1049, 1985. Standard Practices for Cycle Counting in Fatigue Analysis. West Conshohocken, PA: ASTM International, 2011
- Barradas-Berglind, J.D.J., Wisniewski, R., Soltani, M., 2015. Fatigue damage estimation and data-based control for wind turbines, IET Control Theory and Applications 2015, vol. 9 (7), pp. 1042-1050
- Castellani, F., Astolfi, D., Becchetti, M., Berno, F., Cianetti, F., Cetrini, A., 2018. Experimental and numerical vibrational analysis of a horizontal-axis micro-wind turbine, Energies 2018, vol. 11 (2), art. no. 456
- Cetrini, A., Cianetti, F., Corradini, L., Ippoliti, G., Orlando, G., 2018. On-line fatigue alleviation for wind turbines by a robust control approach, under revision at Mechatronics, 2018.
- Cianetti, F. 2012. Development of a modal approach for the fatigue damage evaluation of mechanical components subjected to random loads. SDHM Structural Durability and Health Monitoring 2012, vol. 8 (1), pp. 1-29.
- Cianetti, F., Alvino, A., Bolognini, A., Palmieri, M., Braccesi, C., 2018. The design of durability tests by fatigue damage spectrum approach. Fatigue and Fracture of Engineering Materials and Structures 2018, vol. 41 (4), pp. 787-796
- Collins, J.A. Failure of Materials in Mechanical Design, Wiley, New York, 1981)
- Corradini, M.L., Ippoliti, G., Orlando, G., 2018. Fault-tolerant sensorless control of wind turbines achieving efficiency maximization in the presence of electrical faults, Journal of the Franklin Institute 2018, vol. 355(5), pp. 2266-2282.
- Clormann, U., Seeger, T. Rainflow – HCM – Ein Zählverfahren für Betriebsfestigkeitsnachweise auf werkstoffmechanischer Grundlage. Stahlbau. 1986. Vol. 55, pp. 65–117.
- Gasch R., Tvele J., Wind Power Plants. Fundamentals, Design, Construction and operation, Springer, Berlin, 2012.
- Jonkman, J., Butterfield, S., Musial, W., Scott, G., 2005. Definition of a 5-MW reference wind turbine for offshore system development National Renewable Energy Laboratory, Golden, Colorado (US), Technical Report NREL/TP-500-38060, 2009.
- Jonkman, J.M., Buhl, M., 2005. FAST User's Guide. NREL, Golden (Colorado).
- Long, K., Jia, J., 2015. Analysis of fatigue damage of tower of large scale horizontal axis wind turbine by wind-induced transverse vibration. Taiyangneng Xuebao/Acta Energaie Solaris Sinica 2015, vol. 36 (10), pp. 2455-2459
- Marin, J.C., Barroso, A., Paris, F., Cañas, J., 2009. Study of fatigue damage in wind turbine blades, Engineering Failure Analysis 2009, 16 (2), pp. 656-668.
- Nejad, A.R., Gao, Z., Moan, T., 2014. On long-term fatigue damage and reliability analysis of gears under wind loads in offshore wind turbine

- drivetrains, *International Journal of Fatigue* 2014, vol. 61, pp. 116-128
- Ragan, P., Lance, M., 2007. Comparing Estimates of Wind Turbine Fatigue Loads Using Time-Domain and Spectral Methods, *Wind Engineering* 2007, vol. 31 (2), pp. 83-99.
- Zieglera, L., Gonzalez, E., Rubert, T., Smolka, U., Melero, J., 2018. Lifetime extension of onshore wind turbines: A review covering Germany, Spain, Denmark, and the UK, *Lifetime extension of onshore wind turbines: A review covering Germany, Spain, Denmark, and the UK*, *Renewable and Sustainable Energy Reviews* 2018, vol. 82 (1), pp. 1261-1271